

Creating a Tight Space Exploration Initiative

**Dr. Robert Zubrin
President, Mars Society**

Question: How much rope is needed to connect two posts separated by a distance of 10 meters?

In principle, it can take any amount:



But it can be done with about 10 meters, if the rope is pulled tight.



It is the same with the Space Exploration Initiative.

The issue is whether you want to connect the posts, or whether your goal is to sell rope.

Rope Sale #1

The Lunar Tollbooth

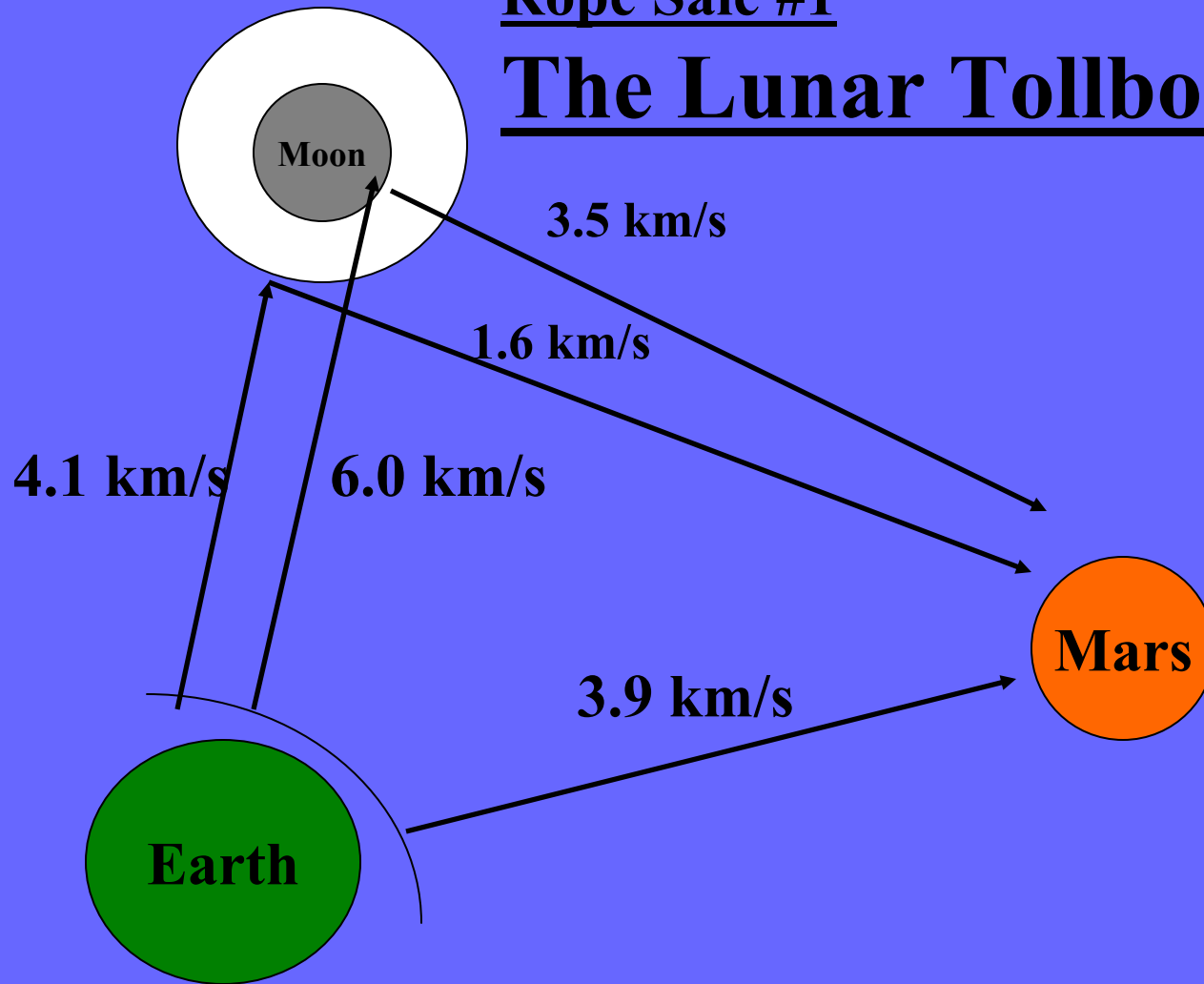

**Even if Lunar refueling were free,
it's easier to go direct to Mars!**



**We can do Mars mission training on the Moon.
But we can do it in the Arctic at 1/1000th the cost.**

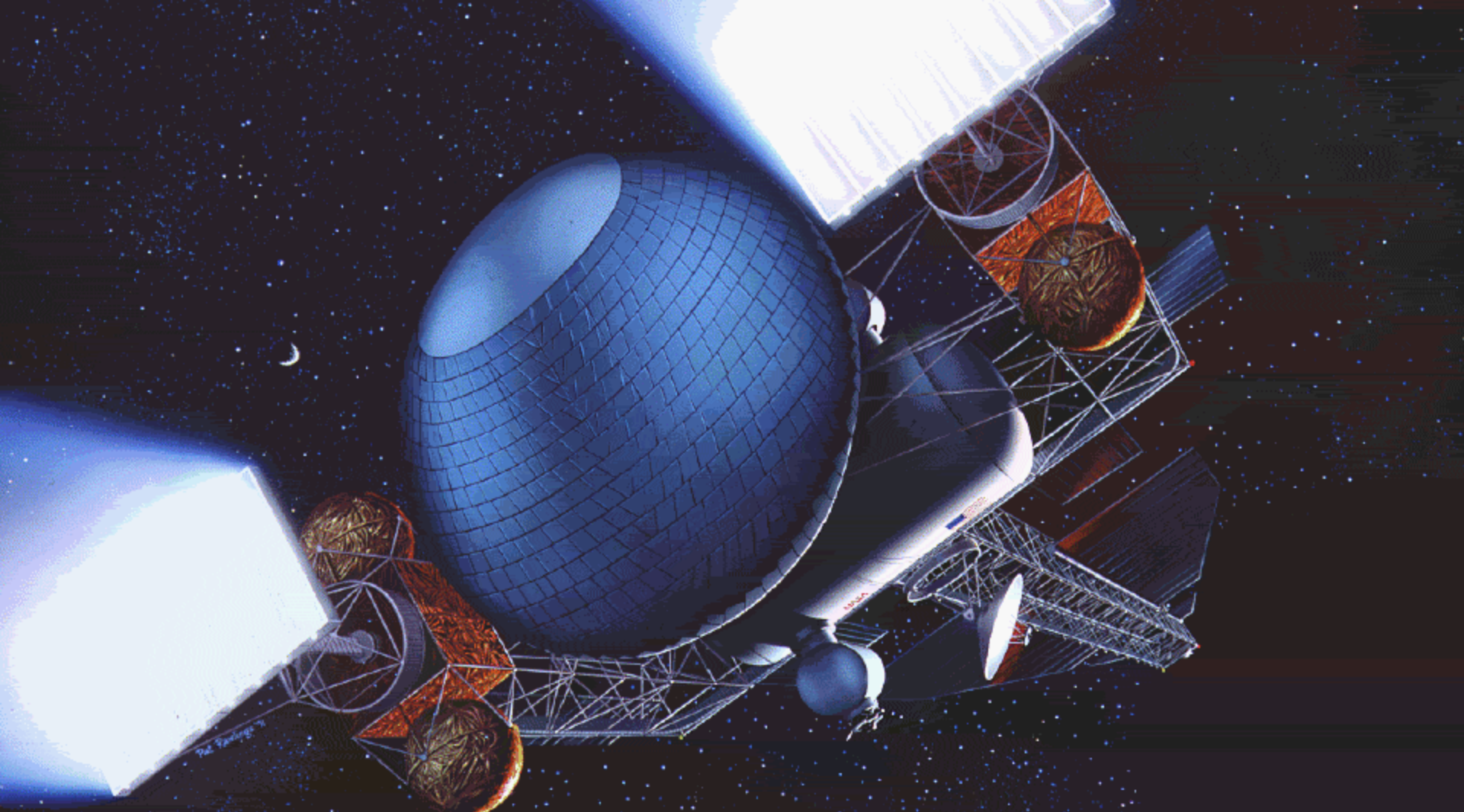

Rope Sale #2

Nuclear Electric Propulsion

Claim vs. Reality

One-way Transit Time

60 days

1460 days

Power Density

3000 W/kg

16 W/kg

Cumulative Radiation Doses Received in Space

Dose (Rem)

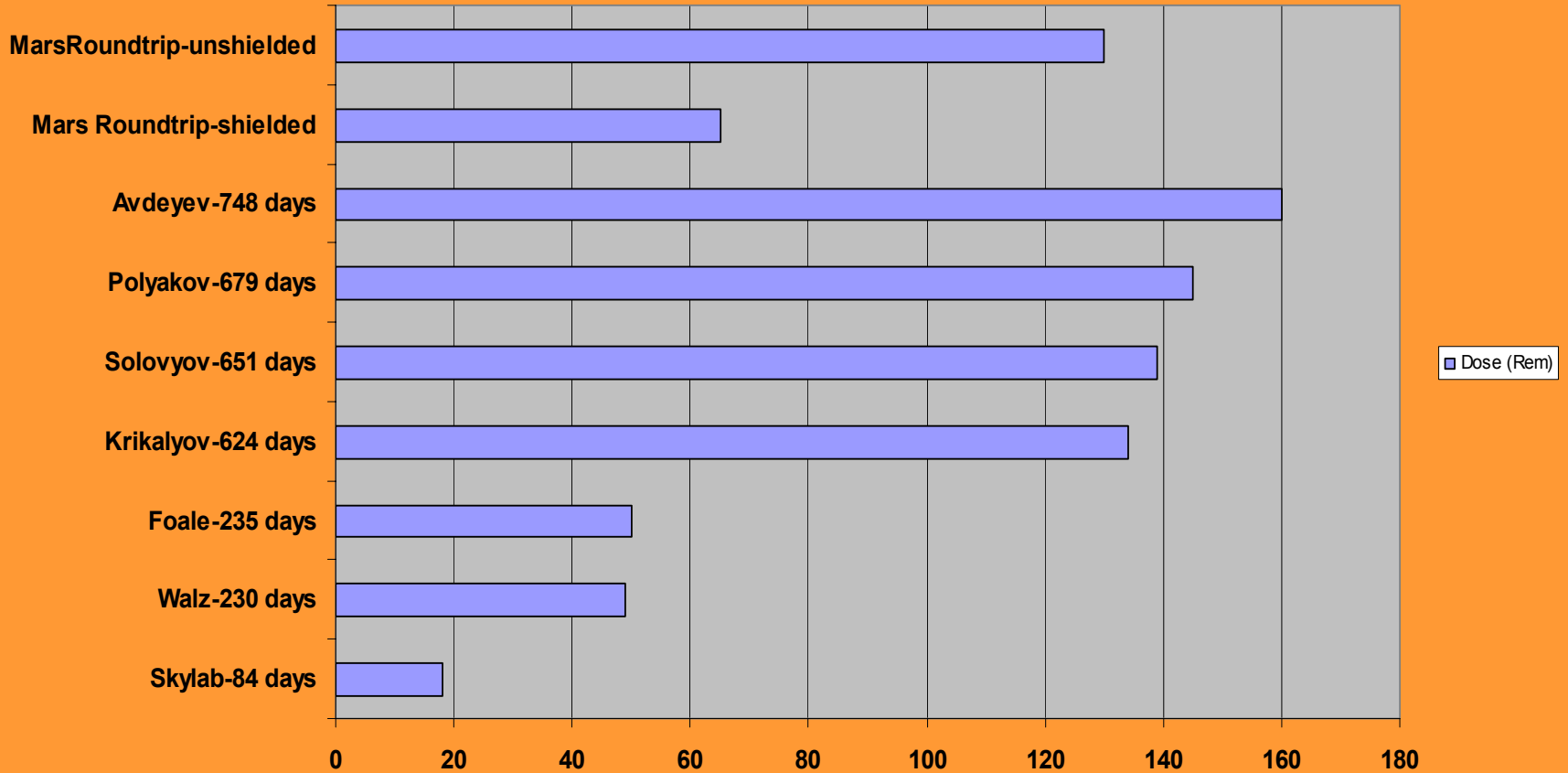

The cumulative radiation dose of a human roundtrip mission to Mars using current propulsion technology has already been experienced by numerous astronauts.

No radiation-induced health effects have been observed.

Ares Launch Vehicle Definition



Payload Capabilities (All Weights in tonnes)

Trans-Mars ($C_3 = 15 \text{ km}^2/\text{sec}^2$)	47.2
Trans-Lunar (5 day transfer)	59.1
LEO (160 by 160 Nmi, 28.5 degrees)	121.2
LEO/NUS (160 by 160 Nmi, 28.5 deg)	75.0

Height (m) 32.3

Gross Mass (Without Payload) 2,194.6

Stage-0

2 Advanced Solid Rocket Boosters 1,214.5

Stage-1

External Tank (Including Residuals)	35.6
SSME Engine Pod (4 SSME's)	28.6
Usable Propellant in ET	723.5
Total SSME Thrust (kN, 104%)	3,706
Specific Impulse (sec)	453
Staging Relative Velocity (km/s)	4.2 to 5.5
(LEO to Mars Range)	

Stage-2 (Ignited Sub-Orbital)

Usable Propellant	158.8
Inert Mass	13.2
Single Engine Thrust (kN)	1,113
Specific Impulse (sec)	465

Payload Fairing (ALS Design) 20.4

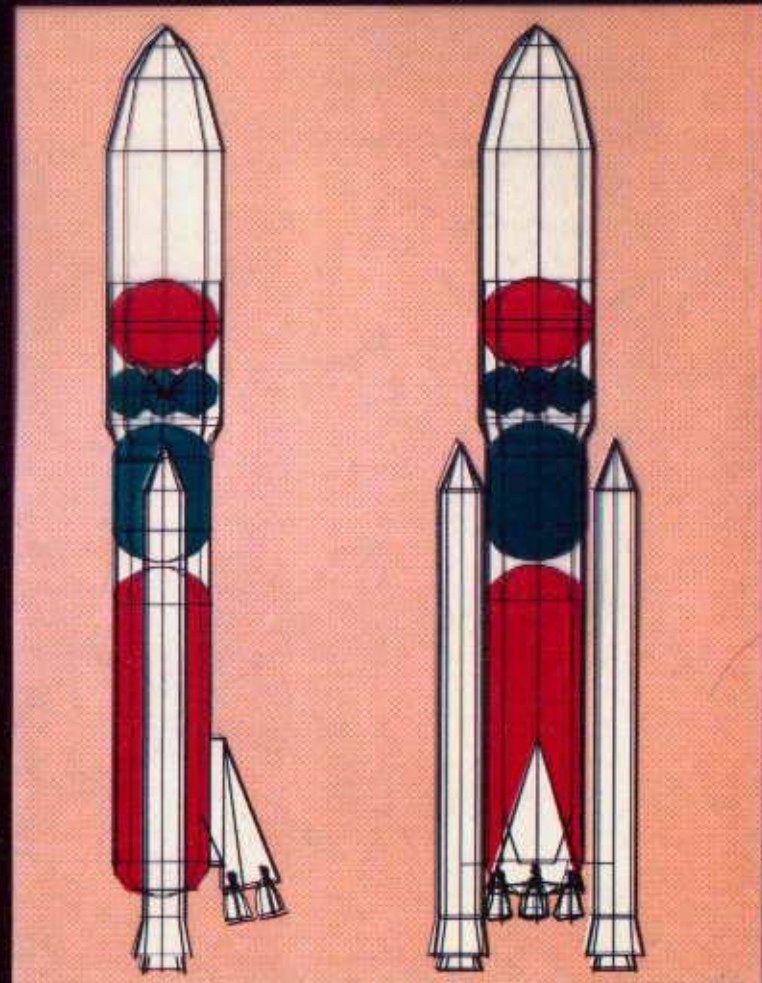

Mars Direct Mission Sequence

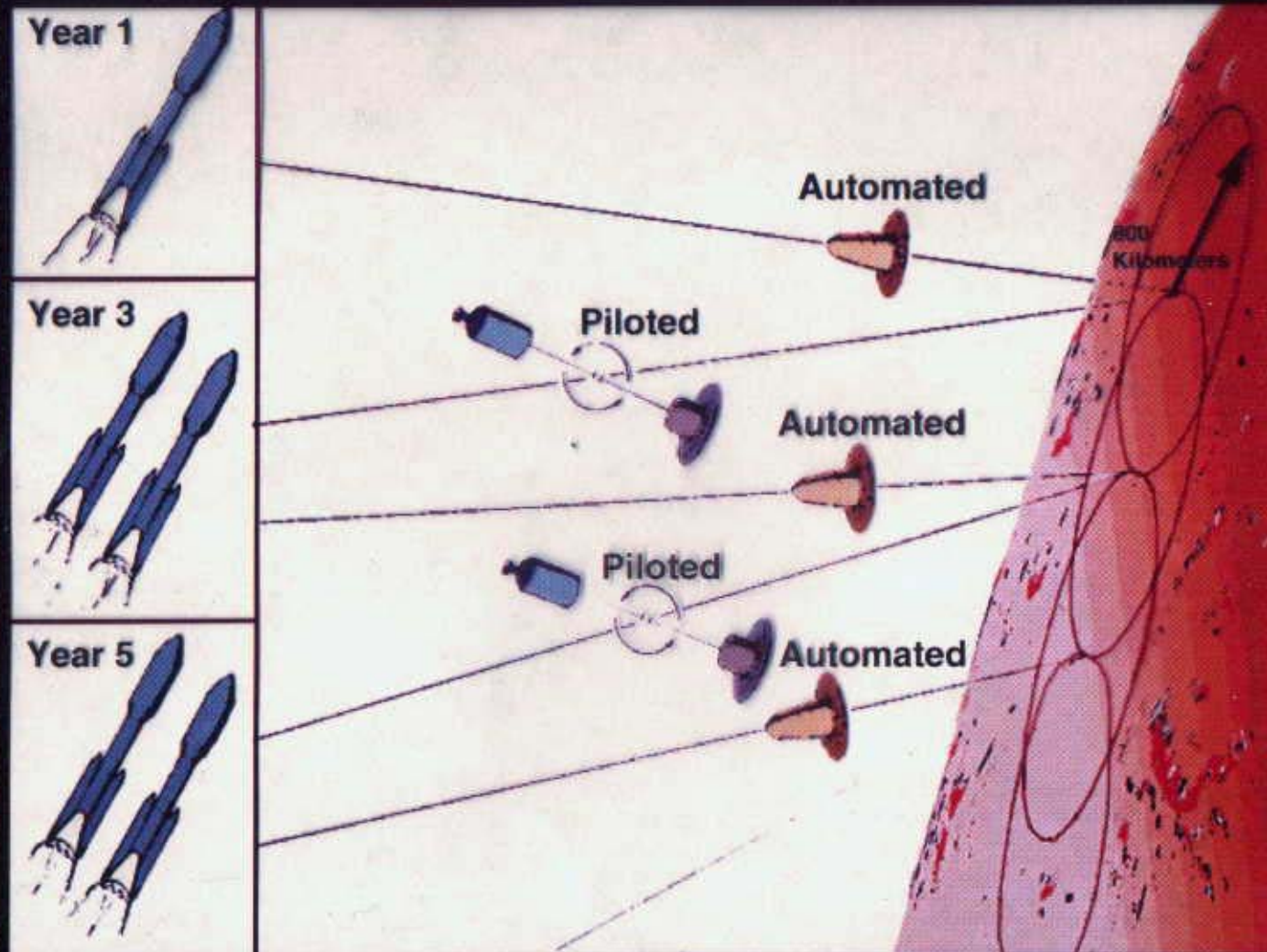

Earth Return Vehicle Definition Sheet



Round Trip Payload

Crew Cab (All Masses in tonnes)	7.10
RCS System	0.40
Biconic Brake (20%)	2.45
Stage-1 Dry (Expended Mars Suborbital)	6.33
Stage-2 Dry	1.77

Mars-Bound Only Payload

Hydrogen for Propellant Prod.	5.81
SP-100 Reactor	4.50

Earth-Bound Only Payload

Crew	0.30
Suits	0.30
Consumables	1.60
Soil Samples	0.10

Stage-1 Propulsion System

Usable Propellant (From H ₂ & Atm)	70.16
Inert Mass	8.85
Total Engine Thrust (lbs)	191,784
Specific Impulse (sec)	373
Propellant Type	CH ₄ /O ₂

Stage-2 Propulsion System

Usable Propellant (From H ₂ & Atm)	22.17
Inert Mass	2.56
Total Engine Thrust (lbs)	20,382
Specific Impulse (sec)	373
Propellant Type	CH ₄ /O ₂

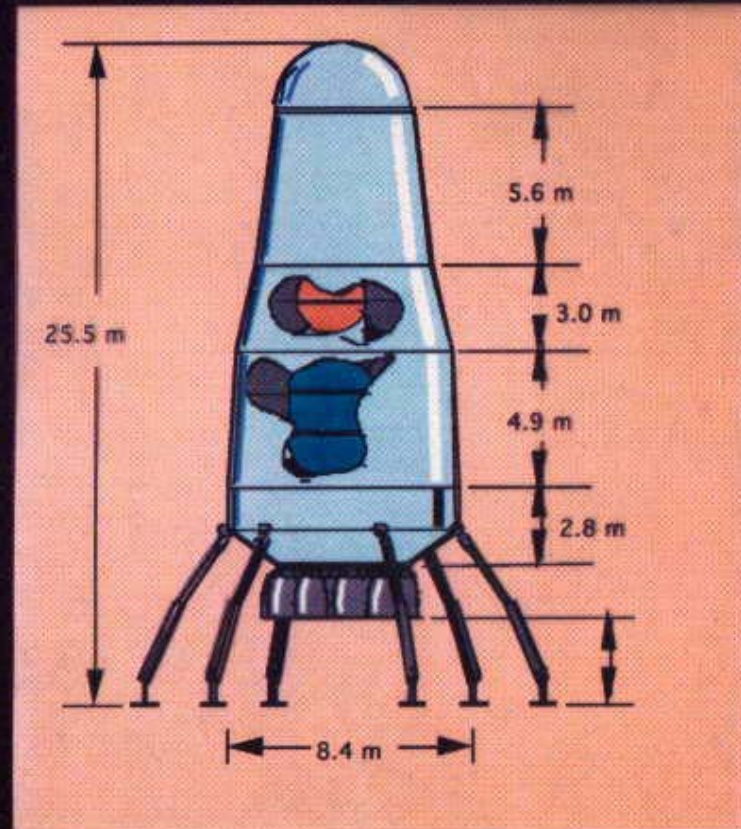

Methane/Oxygen Production Process

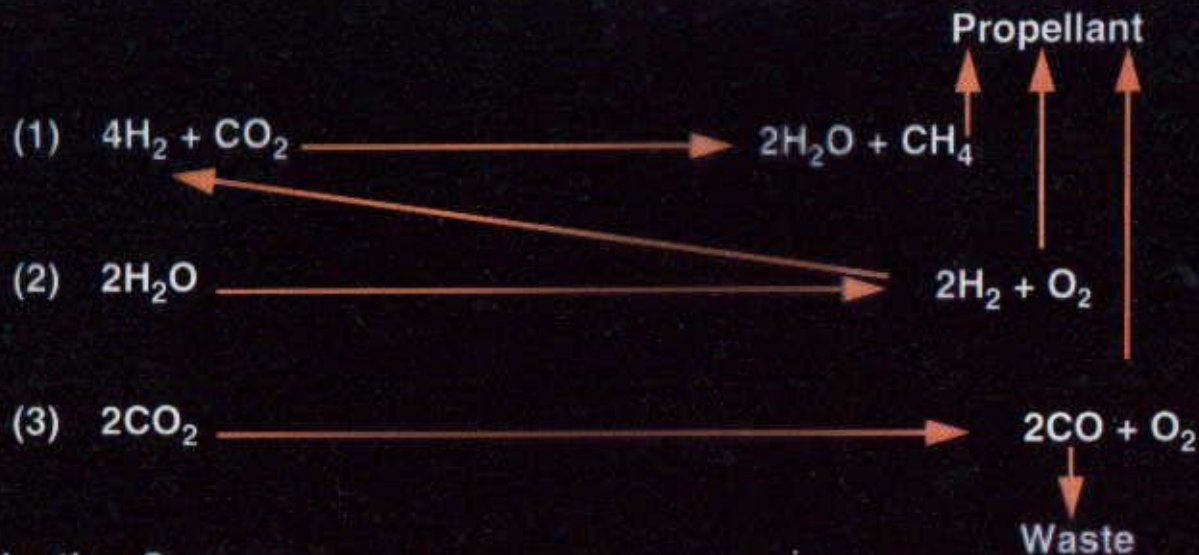

Production Sequence

- SP-100 Reactor is Deployed 200 m Away from ERV By Robotic Light Truck
- 5.8 Tonne of H_2 Brought from Earth Is Reacted with CO_2 To Produce 37.7 Tonne of CH_4 and H_2O via Reaction
- Reaction (2) is Used Iteratively with (1) to Transform this to 23.2 Tonnes of CH_4 and 46.4 Tonne of O_2
- Reaction (3) is Used to Produce 37.1 Tonnes of Additional O_2
- A Total of 106.7 Tonnes of CH_4/O_2 Propellant Has Been Produced, to Be Burnt at a Mixture Ratio of 3.6:1 ($I_{sp}=373$ s)

Mars Direct Mission Sequence

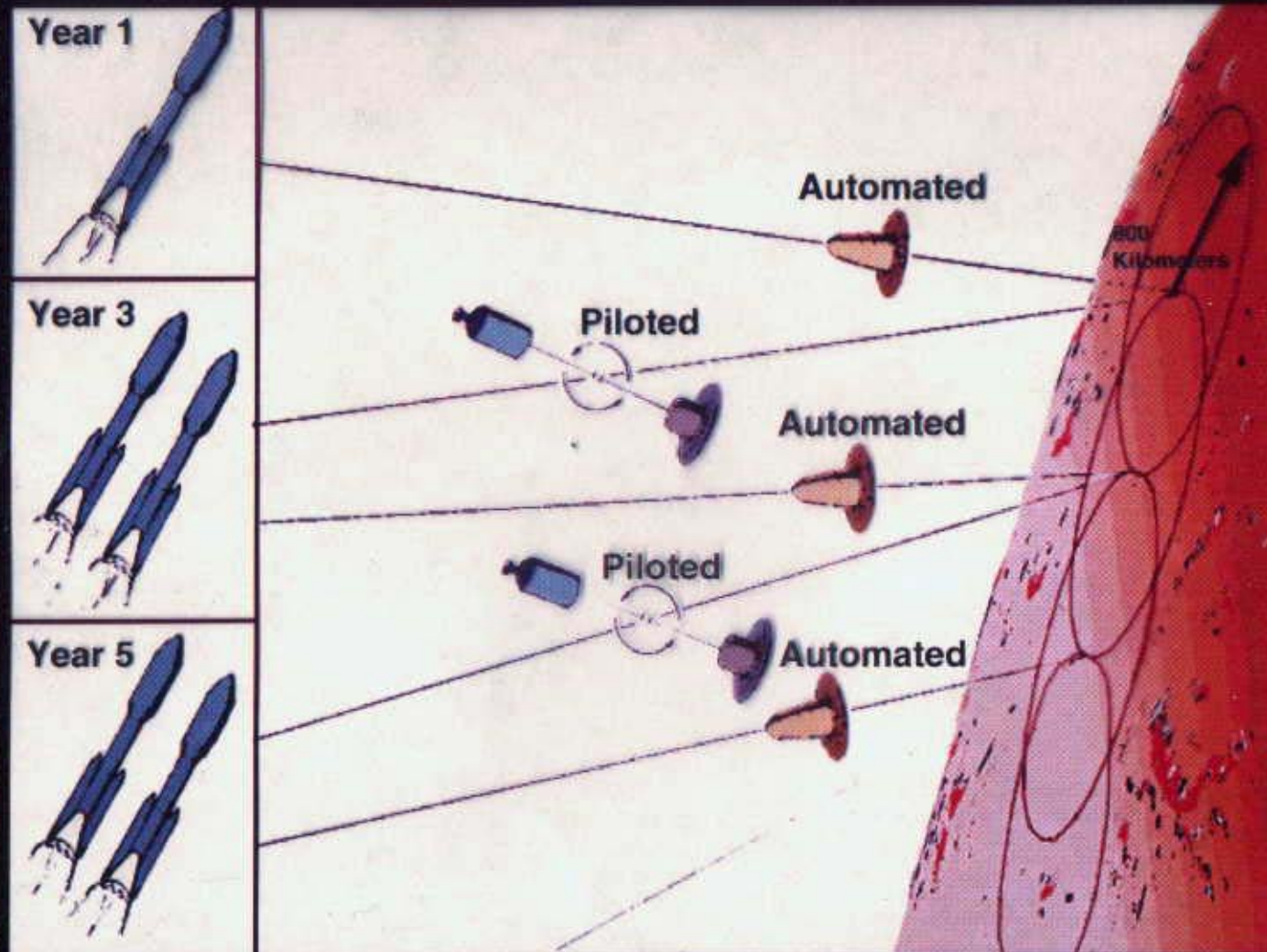

Habitation Mass Definition Sheet



Gross Mass (All Units in tonnes)	28.42
Main Structure (Weldalite)	6.72
Barrel Section Wall	1.97
Decks (3)	2.53
Central Airlock/Rad Shelter	1.82
4 Perimeter Airlock Doors	0.40
Interior Fittings	5.26
Walls	0.30
Furniture	0.45
Science Equipment	0.75
Exercise & Health	0.20
Plumbing & Lighting	0.50
Replacement Air (3 charges)	0.81
Solar Panel	0.25
Life Support System (Closed for Water and O ₂)	2.00
Consumables for Crew (Whole Food)	8.76
Crew	0.30
Personal Effects	0.30
Space Suits	0.30
Pressurized Rover	1.60
Deployed Surface Science	0.40
Contingency	4.17
Artificial Gravity Tether System	0.60

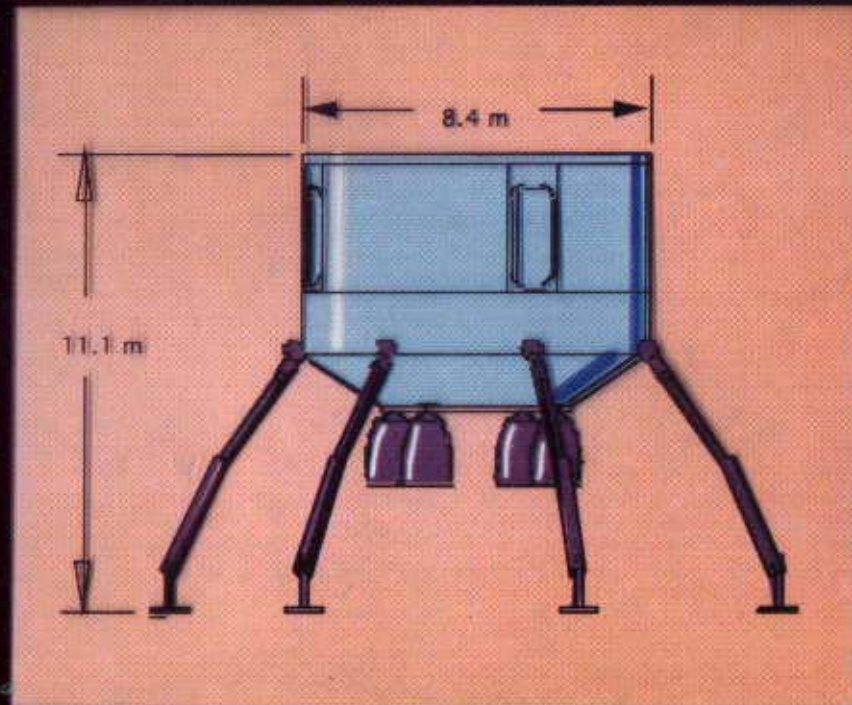

Mars Direct Transfer and Surface Habitation Layout

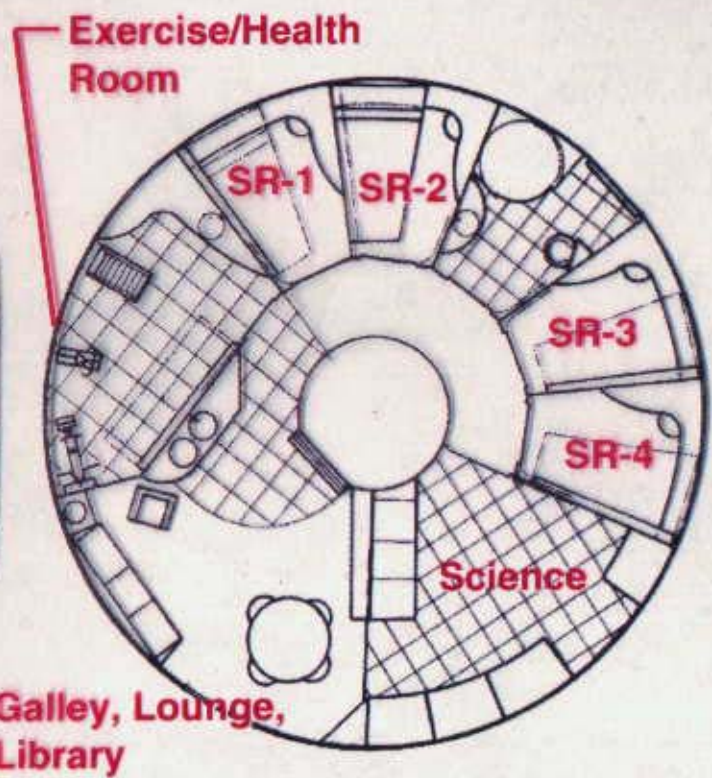
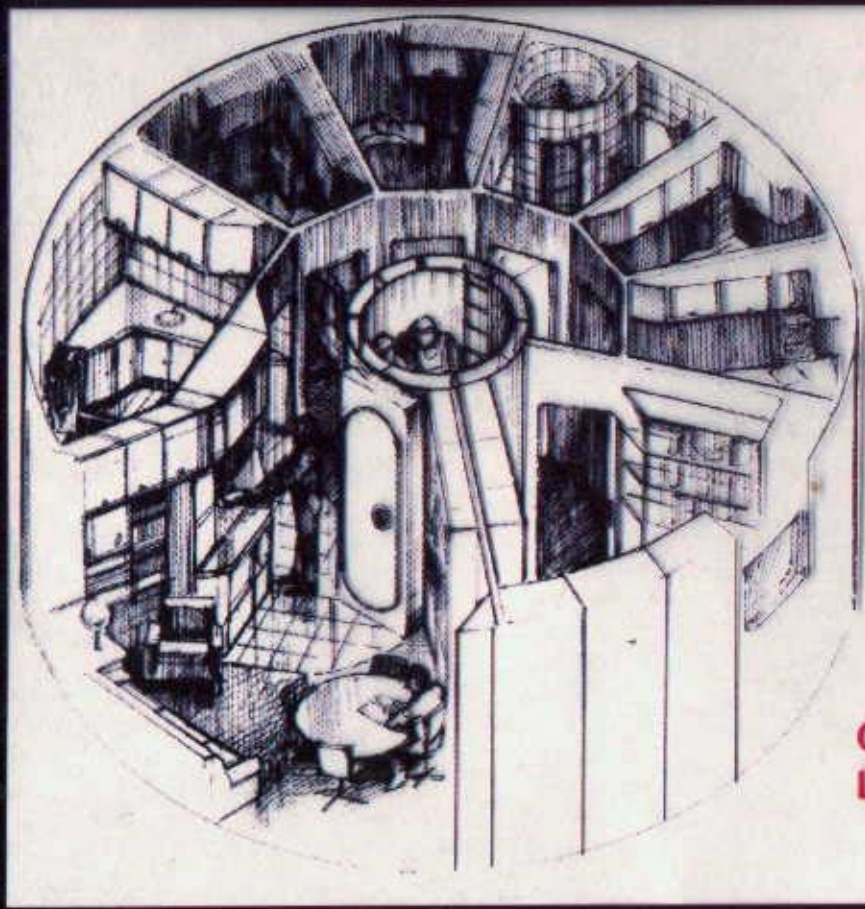

Mars Direct Tether Application for Artificial Gravity



- Mars Gravity Achieved with 1500 m Long Tether at Only One RPM
- One RPM also Reduces Wear on Despun Antennas, Solar Panels etc.
- Mission Continues if Tether Fails
- Spent TMIS is Counter-Balance (Residuals Provide Initial Spin-Up)
- No Despin Required: Tether (and TMIS) Simply Released Near Mars
- Total Tether System Mass is 600 kg based on Kevlar and 2 Safety Factor
- Zero-Burning of TMIS *Reduces* Tether System Mass

Mars Direct Mission Sequence

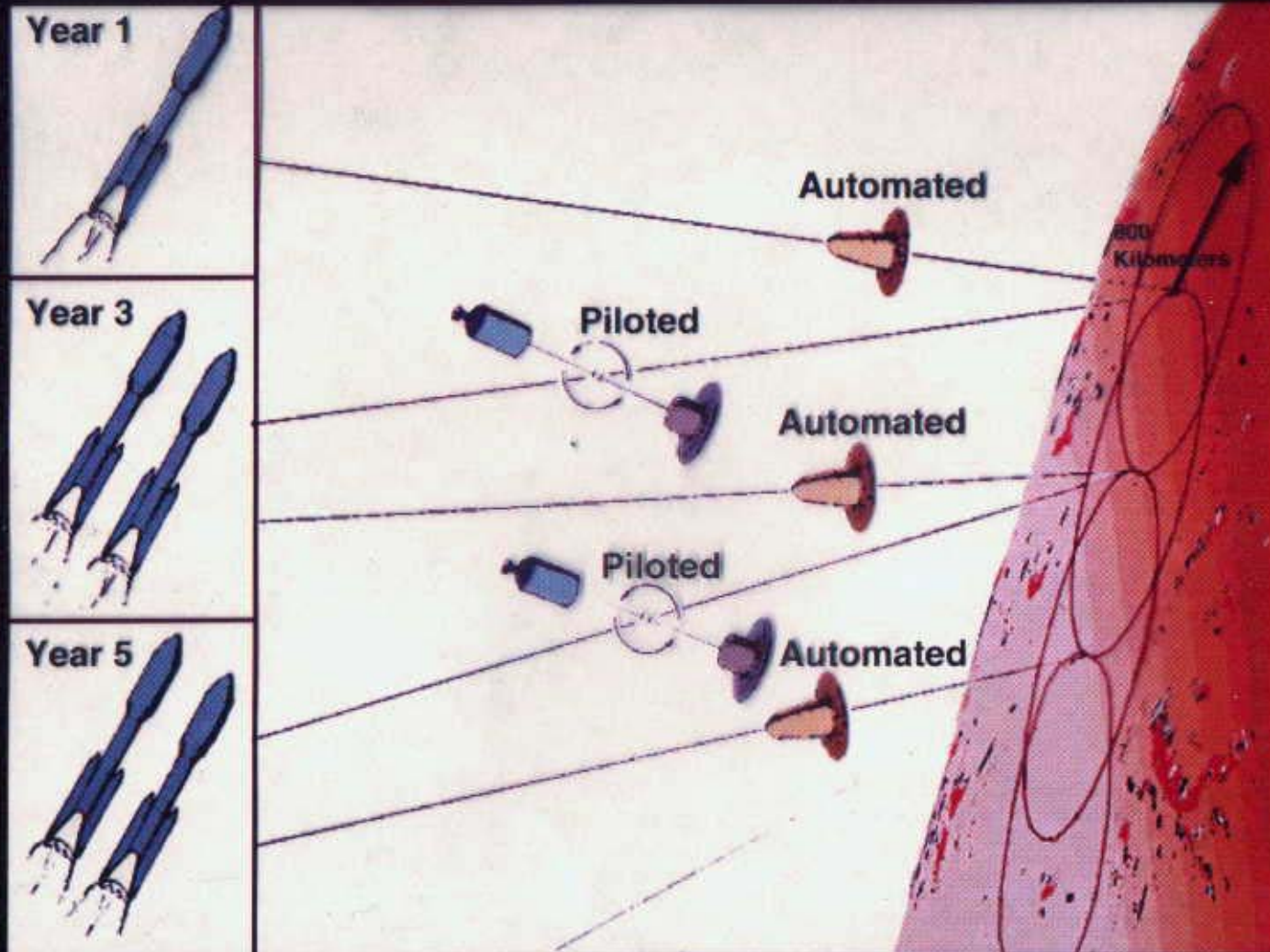

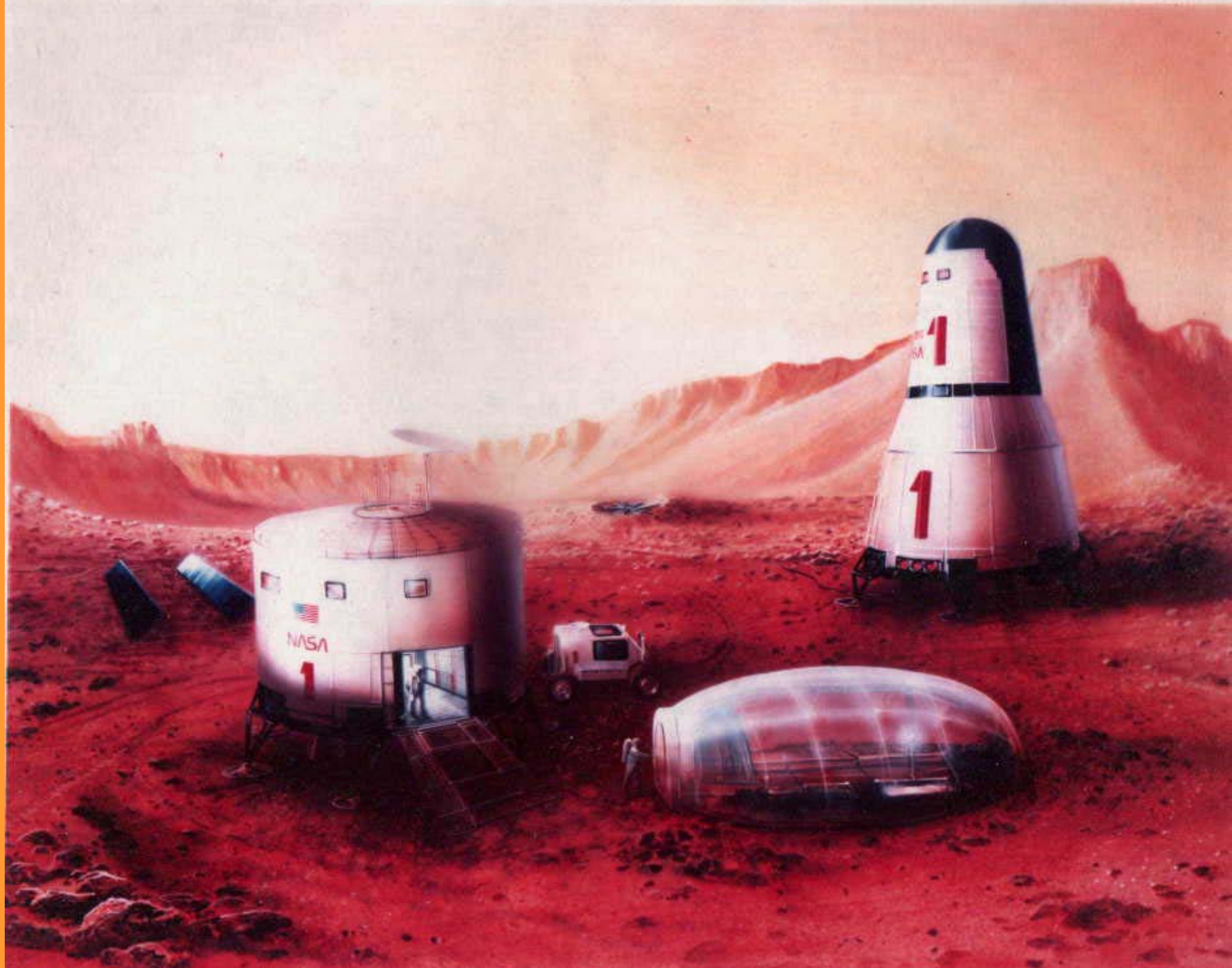

In-Site Propellant Provides the Mobility Needed To Explore Mars



Making the First Mars Settlement Using Mars Direct

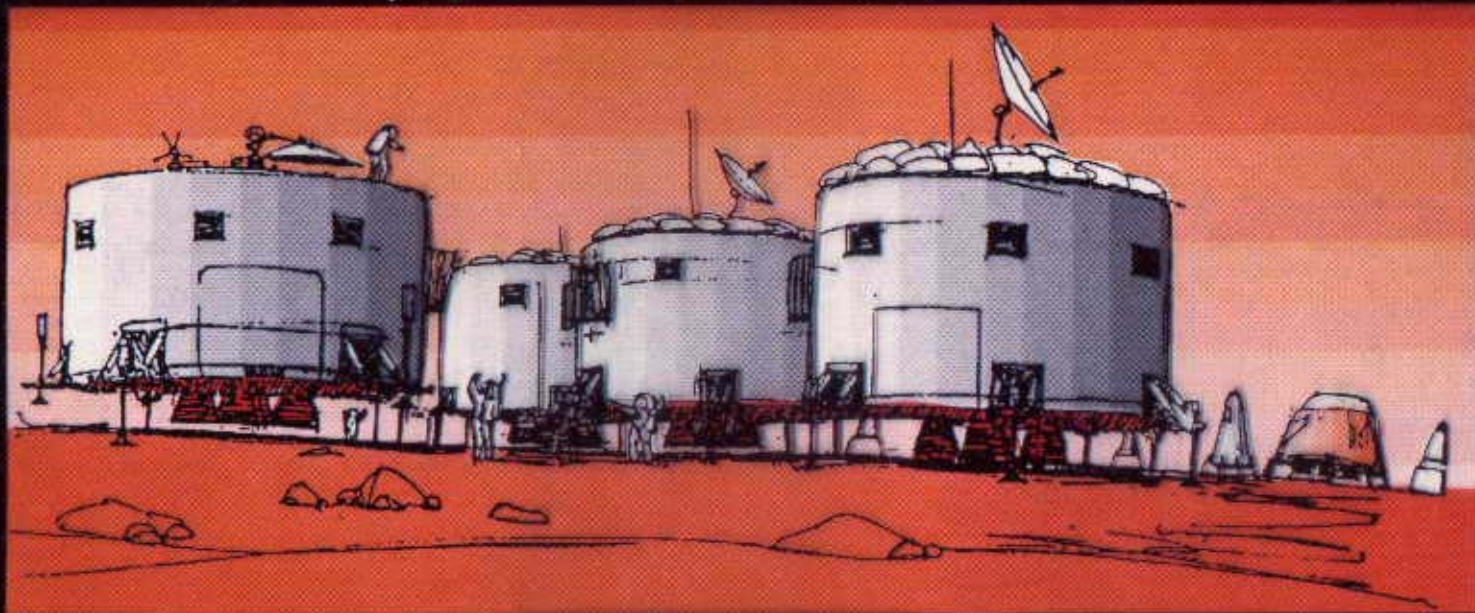

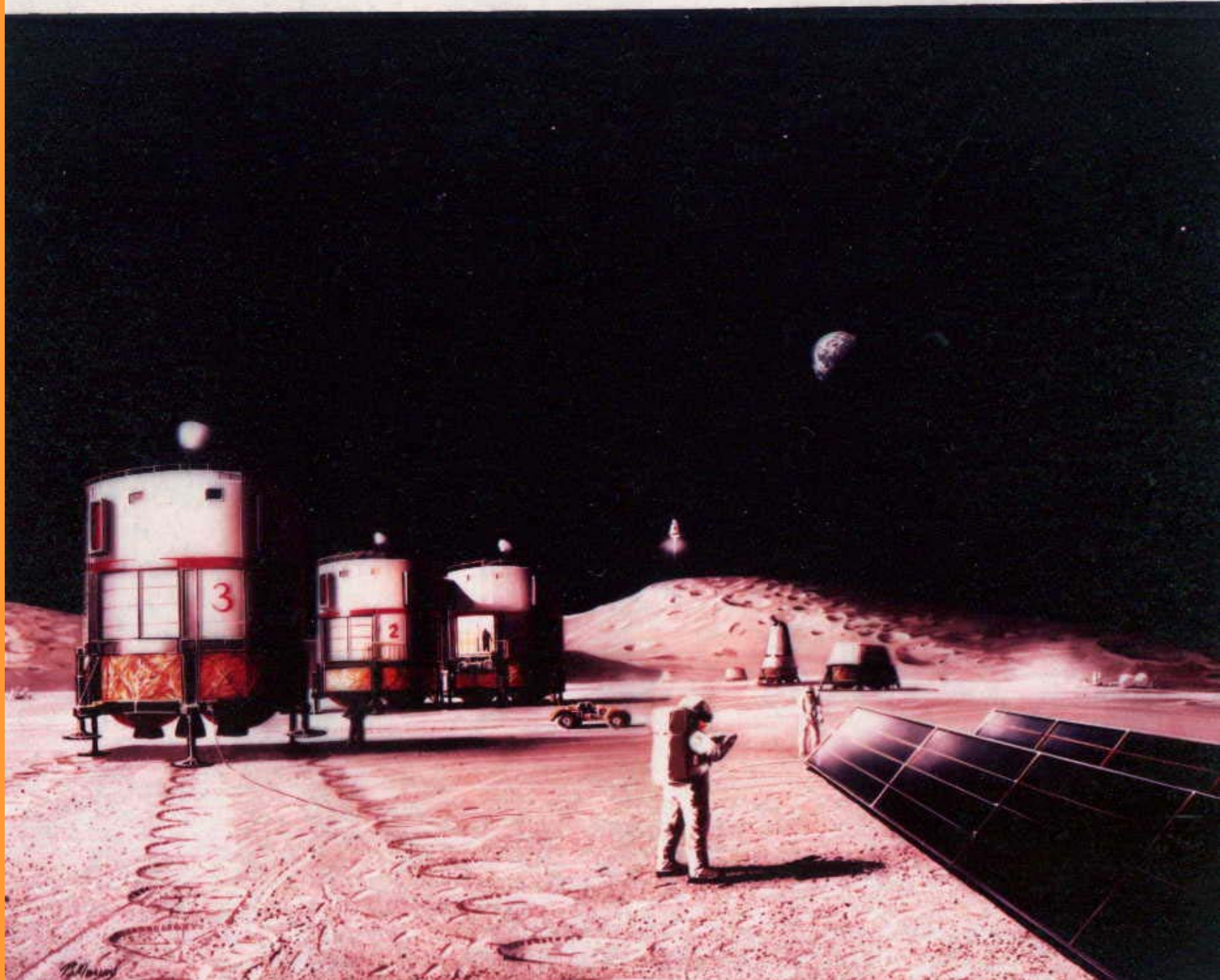

Lunar/Mars Direct Exploration Vehicles

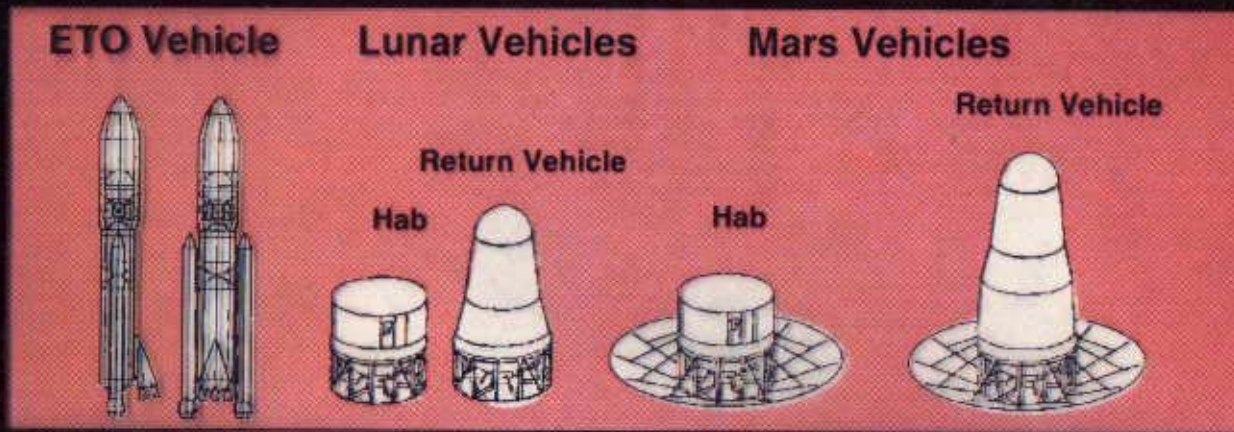

- Common Systems Defined to Explore and Colonize the Moon and Mars
- IMLEO is the **SAME** for either Mars or Lunar Missions: 140 tonnes
- No LEO Assembly Required: Launch Direct to Moon or Mars
- ETO Vehicle is Inline Shuttle-C with Earth-Escape 2nd Stage on Top
ETO Configuration Optimized not to LEO but to Earth Escape
- Mars Mission has Simple Tether Application to Achieve 3/8 g Gravity
- Mars Mission Combines Earth Hydrogen with Martian CO₂ to Create Methane and Oxygen (One kg of H₂ Creates 18 kg of Propellant)
- Surface Habitation and Crew Return Vehicles are Reusable
- No Orbiting Vehicles at Mars or Moon: All Elements go to Surface



“This proposition being made publike and coming to the scanning of all, it raised many variable opinions amongst men, and caused many fears & doubts amongst themselves . Some, from their reasons & hops conceived, laboured to stir up & incourage the rest to undertake and prosecute the same; others, againe, out of their fears, objected against it, & sought to diverte from it, aludging many things, and those neither unreasonable nor unpróbable; as that it was a great designe , and subjecte to many unconceivable perills & dangers. . .

“It was answered that all great & honourable actions are accompanied with great difficulties, and must be both enterprised and overcome with answerable courages.”

-Governor William Bradford, “Of Plimoth Plantation,” 1621